

# An Origami Butterfly for Laura Rozenberg

Founder of the Museo del Origami in Colonia del Sacramento

Designed and diagrammed by Michael G. LaFosse ©2020

## Intermediate level

- A 15 cm square will produce a butterfly with a wingspan of approximately 11 cm.
- Begin with the Minor Color side up.

**Note:** It is best to begin with the paper's grain running vertically in step 1. This will facilitate forming the wings' crescent-shaped edges.

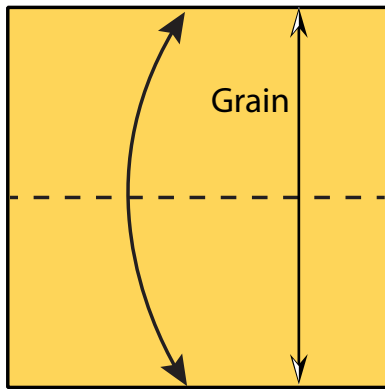
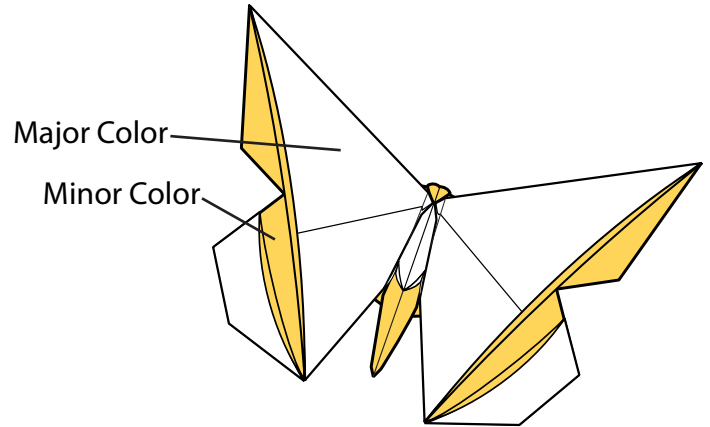

1

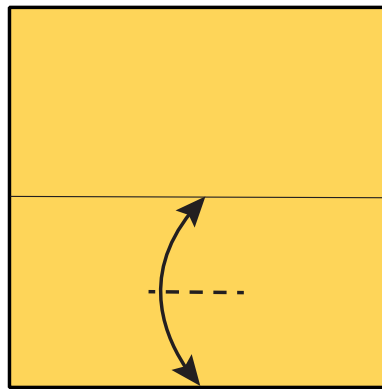

2

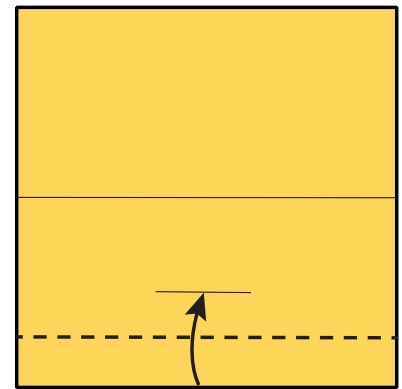

3



4

Turn over,  
bottom to top

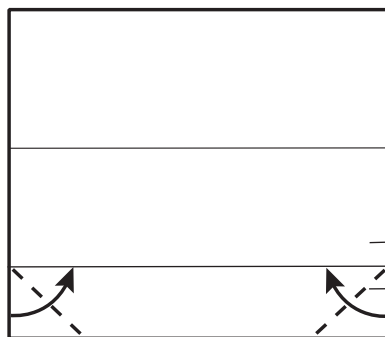
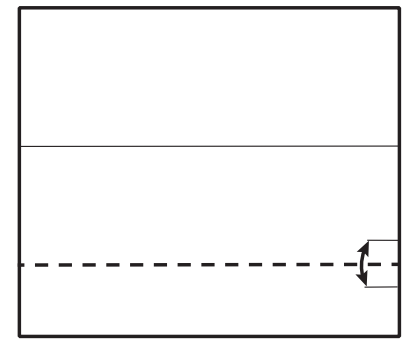
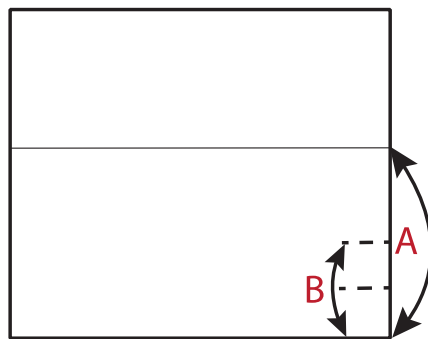

5

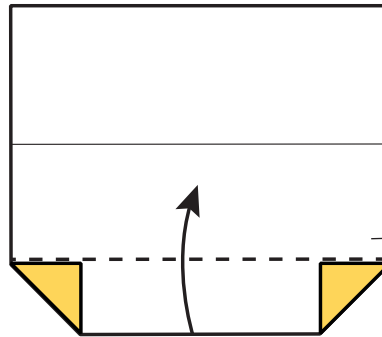

6

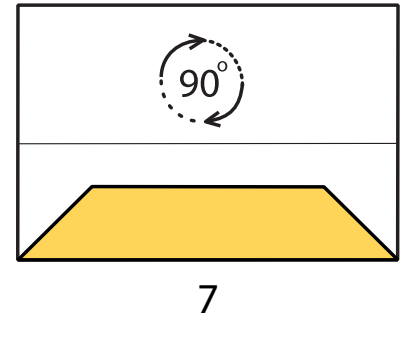

7

# An Origami Butterfly for Laura Rozenberg

Designed and diagrammed by Michael G. LaFosse ©2020

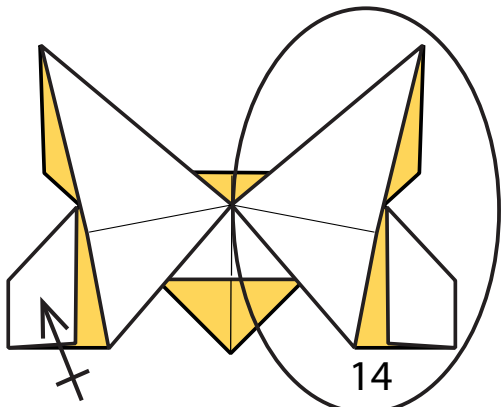
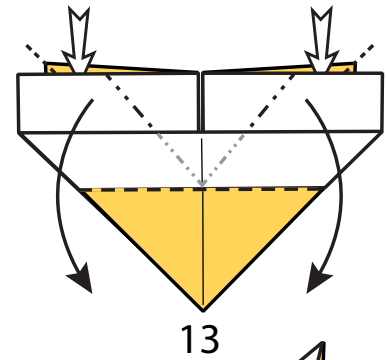
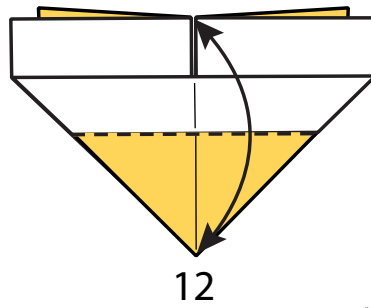
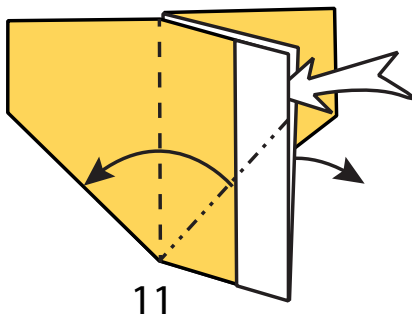
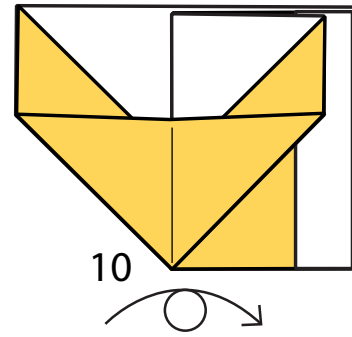
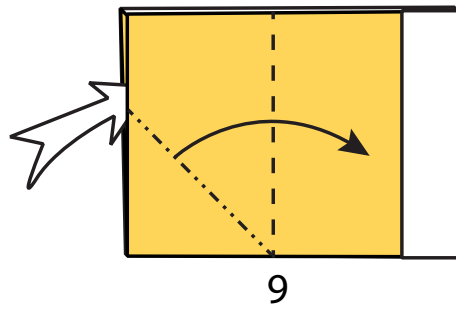
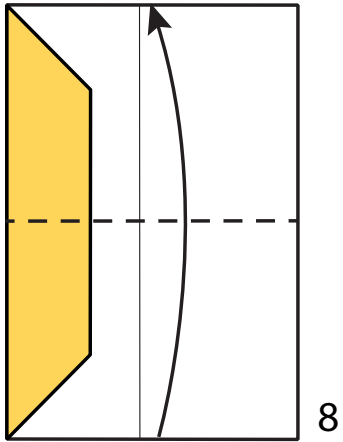

[Repeat steps 15 - 20]

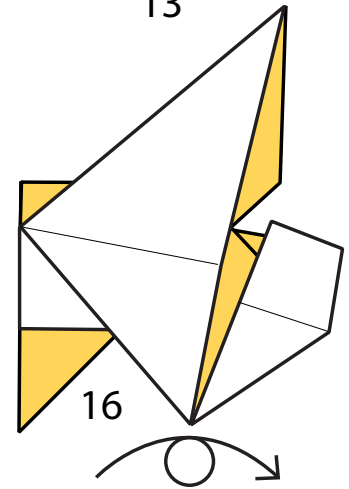
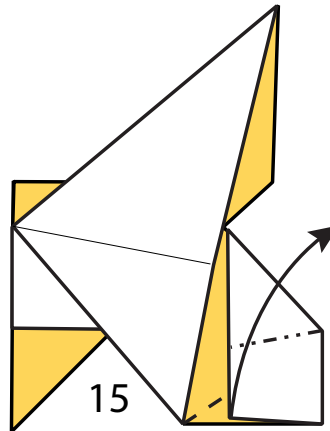

Turn over

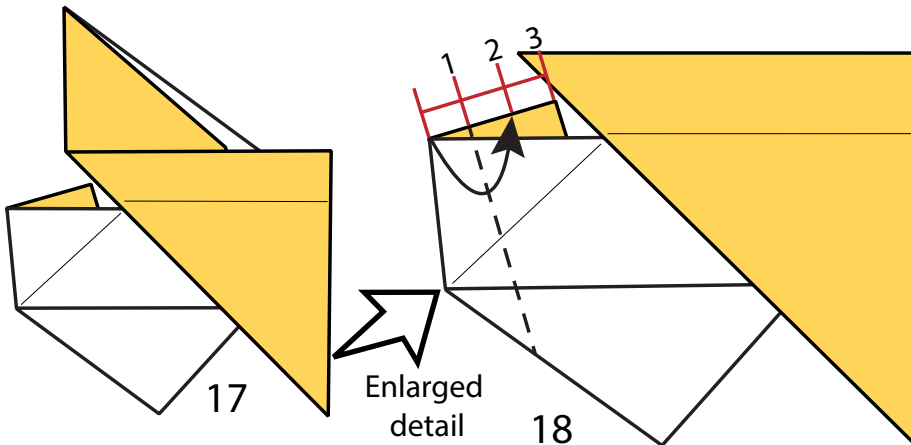

Enlarged detail

18

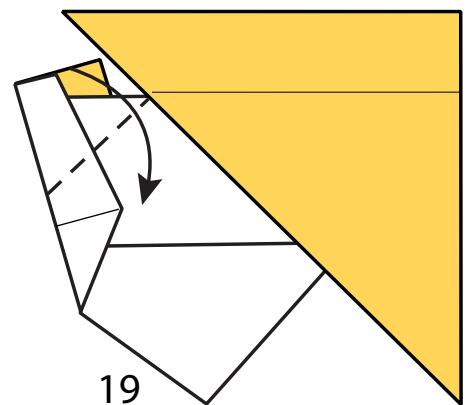

# An Origami Butterfly for Laura Rozenberg

Designed and diagrammed by Michael G. LaFosse ©2020

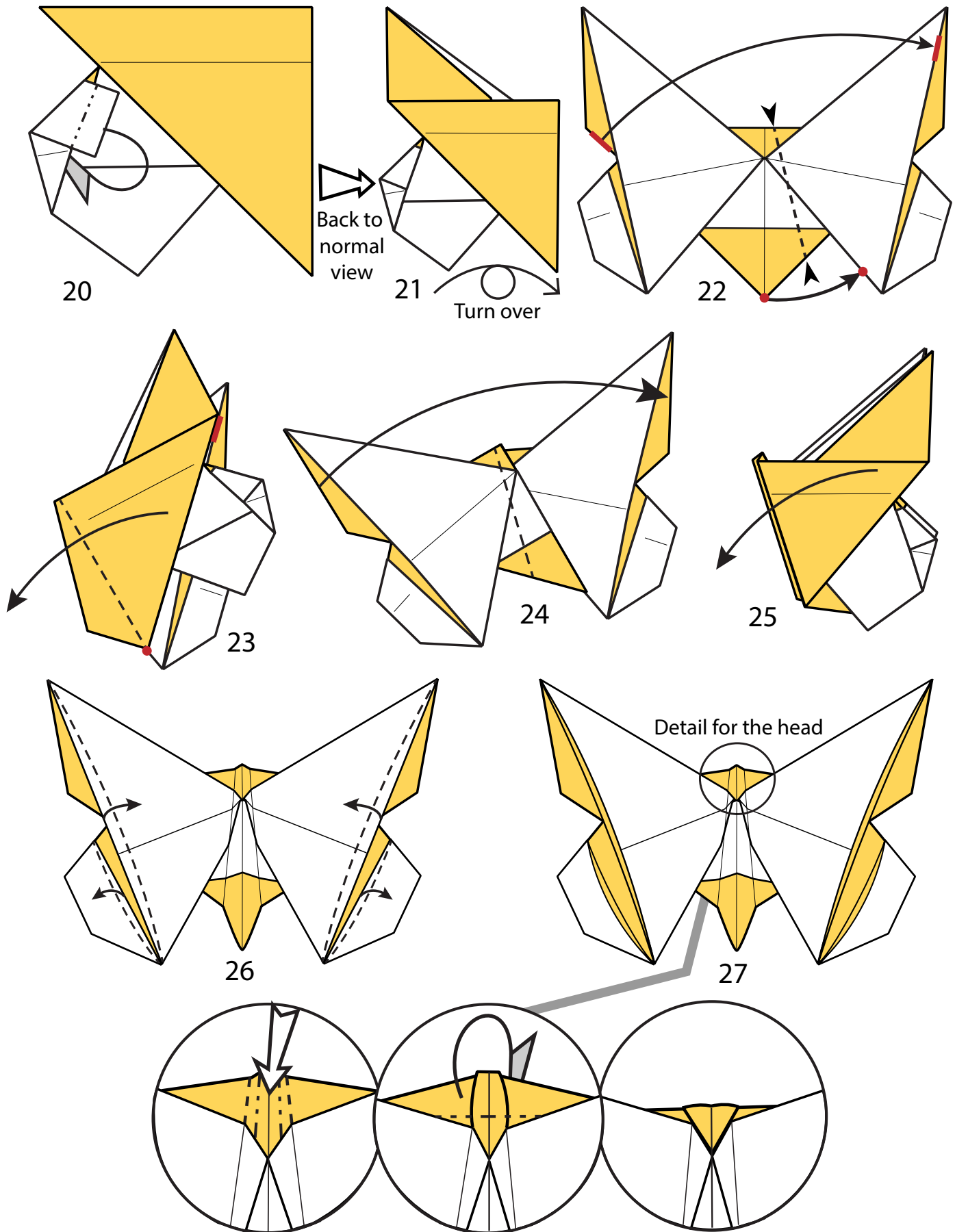

# An Origami Butterfly for Laura Rozenberg

Designed and diagrammed by Michael G. LaFosse ©2020

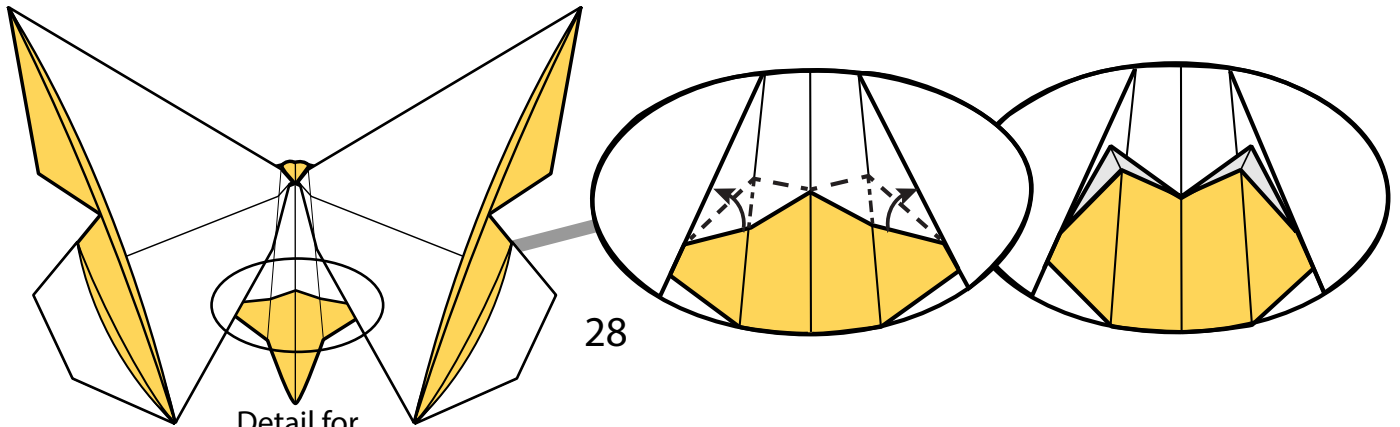

Detail for the thorax

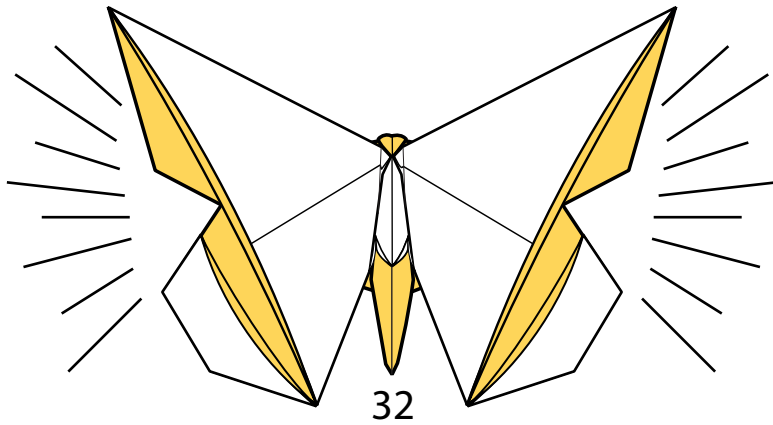
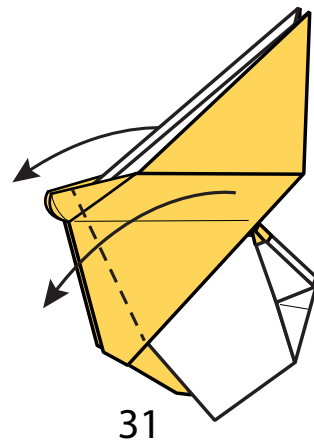
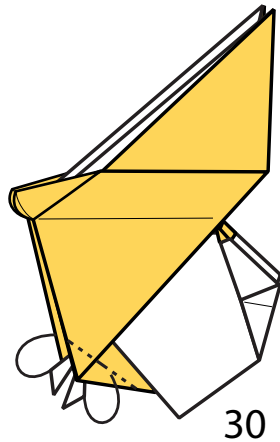
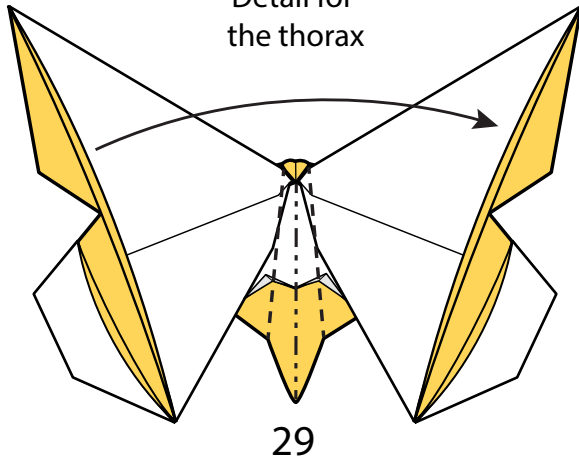

Complete!

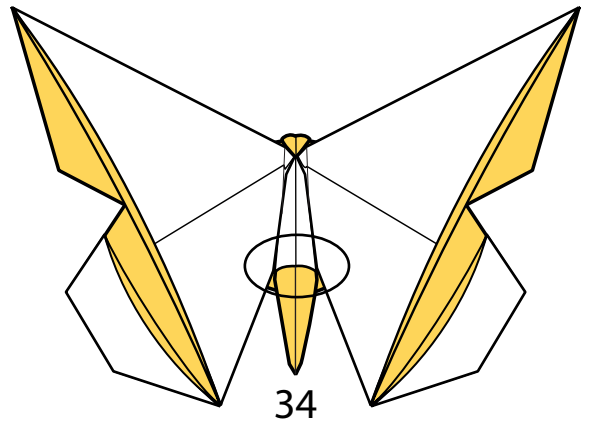

Variation 1: Omit step 28

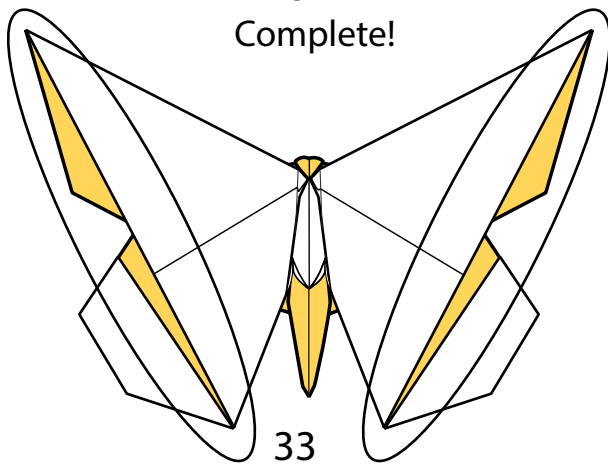

Variation 2: Omit step 26

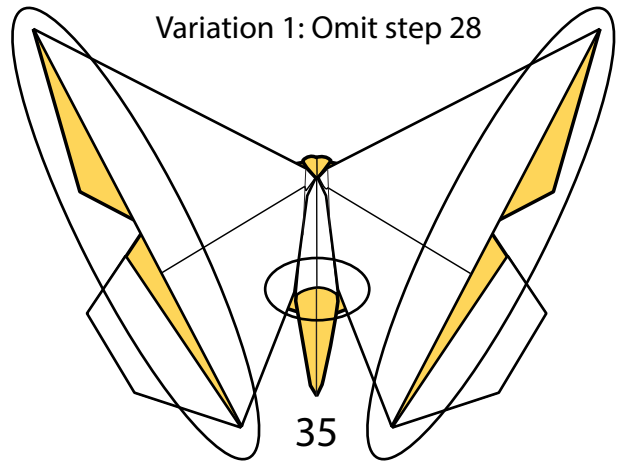

Variation 3: Omit steps 26 and 28